



Owners Manual

Congratulations on becoming a WaterRower owner.

Rowing is universally recognized as the perfect aerobic exercise - smooth, low impact, rhythmic and whole-body - unrivalled for its physiological benefits and aesthetic pleasures.

“Rowing, indoors or outdoors, at any exercise level of intensity, requires a greater exercise expenditure than any other aerobic activity. Calories are burned in relation to the number of muscles used and the intensity and duration of the exercise. Rowing with a sliding seat uses a very large muscle mass since the upper, lower and trunk muscles are used vigorously”

Dr. C Everett Koop- Former US Surgeon General

While most rowing machines imitate the action of rowing, they do so mechanically, and therefore lack the natural dynamics experienced when a boat and crew glide down a river. At WaterRower, we have focused on replicating the physical dynamics of rowing, with the knowledge that this will achieve all of its physiological benefits, as well as much of the aesthetic pleasure.

To maximize the enjoyment from using your WaterRower we recommend that you follow our suggestions on rowing technique and exercise programmes. We hope that some of the discussion points in this manual will improve your knowledge about exercise in general, so that you are better able to fulfil your specific exercise objectives.

Your WaterRower has been carefully hand-crafted to give you years of trouble-free use. We recommend that you closely follow the assembly details provided, particularly by assembling the machine in the correct sequence, and adhering to the suggested maintenance schedule.

We hope you enjoy using your WaterRower for many years to come.

RESISTANCE SETTINGS

The WaterRower is unique in using the effect of drag to provide an exercise which is entirely self paced. Because drag is linked to speed, a crew rowing down a river chooses its intensity of exercise simply by altering the pace at which they row: the faster the boat travels the greater the drag and the harder the crew must work. This is a similar effect to swimming.

By replicating these dynamics the WaterRower does not require adjustment to increase resistance: if a more intensive workout is required, simply row faster and harder, and the WaterRower will respond accordingly.

WATER LEVEL

The amount of water in the tank simulates the weight of the boat and crew as it glides down the river. Changing the water level does not change the resistance, it simply changes the mass which the user is trying to move. Increasing the water level simulates a heavier boat and crew mass, similarly reducing the water level simulates a lighter boat and crew mass.

The water level is adjusted according to one's personal preference or user type; the intensity of course is altered simply by moving the chosen mass faster or slower. A level gauge is positioned on the tank just below the computer. Typical settings are:

Children	12-14 liters
Women	14-16 liters
Athletes	16-18 liters

NOTE- Fill the tank with ordinary municipal water. Municipal water contains additives which will deter algae growth. Distilled or purified water has had these additives removed, promoting algae growth, and should therefore be avoided. [Refer to the section on Periodic Maintenance for advice on water treatment]. Should the environment in which the WaterRower is stored be subject to freezing, we recommend adding alcohol to the water.

Safety

We recommend consulting a physician before starting out with an exercise program. Please read all instructions before using the WaterRower. Additional information on getting started, rowing technique and rowing training advice can be found at www.HowToRow.com.

⚠ Warning: Please keep hands away from moving parts when rowing machine is in use.

For further information on safety tips, please refer to www.waterrower.com/safety.



HEEL REST POSITION

The heel rest has been designed to be adjusted for maximum comfort. The foot strap is designed to cross the foot at the pivot point of the toes (the ball of the foot). This should enable the heel to be raised off the footboard as the user comes forward with each stroke. The heel rest can be easily adjusted to accommodate different users by pressing the button between the foot straps and moving the footpads as shown.

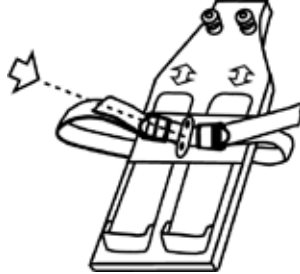

ROWING TECHNIQUE

Correct rowing technique is essential to realizing the full benefits of the WaterRower, reproducing the excellent physiological and aesthetic benefits of rowing.

The fundamental elements of the rowing stroke involve co-ordinating the motion of your legs, back and arms. The rowing stroke uses all of these muscle groups, and because these muscle groups vary greatly in strength it is important to use them in the correct sequence.

The following seven steps may be followed to assist you in adopting the correct sequence and most importantly, posture.

It is important that the sequence is smooth, even and flowing, producing a uniform transition of power to the water, free from any jerkiness.

The Finish Position - legs flat, abdominal muscles support the torso, pressure still on foot board.

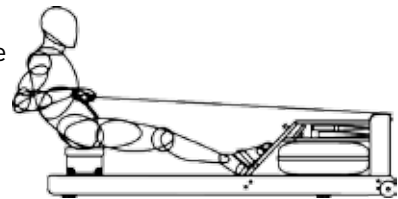

The Recovery Phase

Stage 1 - arms straighten first, the body starts to rock over the pelvis.

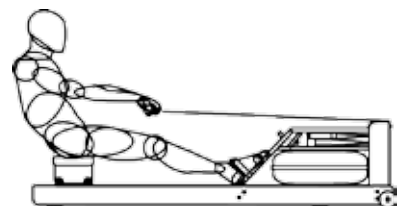

Stage 2 - the pelvis rocks over, body weight shifts from the back of the seat to the front of the seat.

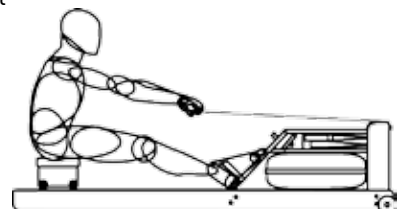

Stage 3 - the body moves smoothly up the slide in the rocked over position. Pressure comes gradually onto the feet as the shins become vertical. Shoulders and arms are completely relaxed, head up. This is the 'CATCH' position.

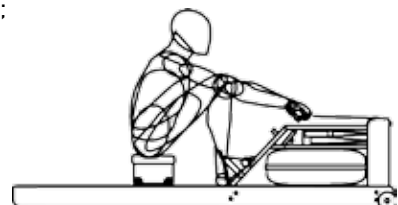



The Drive Phase

Stage 1- the leg drive: push back with your legs, keeping your back tilted slightly forward, your arms straight and relaxed and shoulders loose.

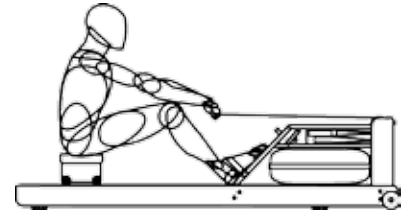

Stage 2- as the leg drive continues at a constant speed, your body begins to open out, and shoulders move back, adding to the acceleration created in stage 1.

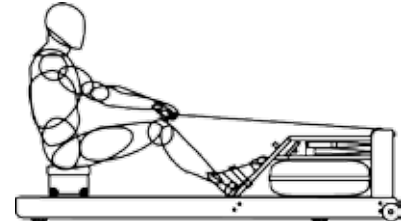

Stage 3- maintaining a constant speed, the body opens out and the arms begin to bend as the legs approach the flat position.

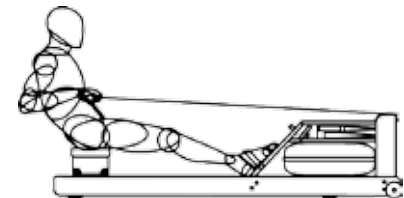

The Finish Position - arms draw the handle to the base of the rib cage as the back is held firm. Toes press against the foot plate.

THE BASICS

These diagrams show the positions that you should pass through during the stroke cycle. If you can, position a mirror side-on as you row to check your technique. For beginners it is important to check the co-ordination of arms, back and legs. Note that during the drive phase your body opens out legs first, then back and arms later, and that during the recovery phase in-between strokes the arms straighten and the back rocks over before the legs bend. As a result the handle should move back and forth in a straight line and you can use this to check your technique - if you have to lift your hands over your knees at any point then you're doing it wrong!

TIPS FOR GOOD TECHNIQUE

Rowing is a leg-driven exercise to which arms and back merely 'add on' to the acceleration generated by the legs. Accelerate the handle evenly throughout the whole stroke, and keep an even pressure on your feet throughout the entire work phase.

During the recovery, move your body by rocking your pelvis rather than by curling your spine. This keeps your lower back in a strong position and, if you do it correctly, you should feel your weight shift from the back to the front of your seat as you rock over. If you have difficulty doing this while your legs are flat it is important to work at your hamstring flexibility, as tight hamstrings pull your pelvis into a weak-back position.

Stay relaxed in the upper body - particularly the shoulders. During the drive phase imagine that you are 'hanging' off the handle as you move back. This cuts out unnecessary tension and also ensures that you are not working your back against your legs at the catch.

SOME USEFUL EXERCISES

A useful training aid used by oarsmen at all levels is to break the stroke down into constituent parts so as to separate out each movement. Two drills are particularly useful:

Fixed-seat rowing - practice rocking from your pelvis and keeping some pressure to your feet by moving back and forth between positions 1 and 3 - effectively rowing without driving with your legs.

Catch drill - practice shoulder relaxation and leg-back co-ordination by moving back and forth between positions 4 and 5. In this phase of the stroke the legs do everything so your body angle should stay the same and your arms should be straight throughout the exercise.

Practice each drill for a minute or so and then return to full-range rowing. This will enable you to feel the effect of each drill on your co-ordination.

For further information on technique we recommend that you contact WaterRower or visit our rowing education web site at www.watercoach.com.



STRETCHING AND WARMING UP

As with all training, the importance of stretching and mobilization cannot be over emphasized. Particularly relevant to rowing are hamstring stretches and back and shoulder stretches. Do these as part of your warm-up and warm-down.

We have included some diagrams which you may find helpful. We recommend that you consult a physiologist prior to attempting these stretches to ensure that they suit your physiology.

Hamstring stretch - keep your hips parallel to the ground, and both hips and shoulders square and facing forwards. Both feet should point slightly inward, and toes up. The supporting leg should be straight and weight on the inside of the supporting foot. Pivot your back at the hips to stretch your hamstring.

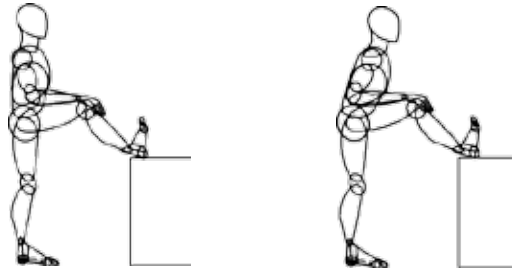

Back stretch - should be performed with your hips on the ground and repeated 7-10 times. Mobilization and short stretches should be used before your work out, and longer stretches after. If you are doing sessions of longer than 45 minutes it is also a good idea to stop and stretch half-way (just back and hamstrings) - you will not lose training benefit significantly and this can protect against injury.



HYDRATION

Hydration is important, especially if conditions are warm. Drink water during your short stretching breaks in long sessions and ensure you rehydrate after training.

EXERCISE PHYSIOLOGY

Most of us recognize the benefit of exercise and the potential improvements to our general health and well being. However few of us, including the sporting heroes whose physical exploits we may admire, fully understand the physiology of exercise and the best means of achieving specific exercise objectives.

To get the most out of any exercise program it is essential to have a clear understanding of what your exercise objectives are. These may include developing bulging muscles, improving general strength, reducing or maintaining weight, improving sporting competitiveness or simply avoiding the health consequences of a modern sedentary lifestyle.

Many of the commonly held beliefs relating to exercise are poorly substantiated and some are completely fictional. A classic example is the old adage "no pain no gain" which unnecessarily associates exercise with discomfort.

Here we explore some of the realities of exercise physiology, and try to highlight the best ways to achieve certain exercise objectives and hopefully dispel some of the myths.

Let us start by separating exercise programs into two distinct groups, resistance based and aerobic based.

RESISTANCE BASED EXERCISE

Resistance training is designed to improve either muscle strength or size. The muscle cells are purposely damaged through a process of overloading, the body reacts instinctively to repair the damaged cells so they can cope with any future overload, increasing their size and strength in the process.

The muscles themselves do not actually increase in number, as some might think: the human body has a genetically defined number of muscle cells.



Muscular fitness is a combination of strength, endurance and flexibility. Resistance training occurs over a short time frame and does not necessarily improve endurance capacity or for that matter flexibility. There may even be a decrease in endurance capacity because as the muscle cells grow the fluid between the cells, essential to oxygen transportation, is reduced.

There is also evidence to show that resistance training can cause an increase in blood pressure.

AEROBIC BASED EXERCISE

Aerobic training relates to the processes by which the body generates the energy to perform work. The principal fuels used to produce energy are the body's stores of fat, carbohydrate or protein. These fuels can be converted into energy by one of two processes, the aerobic metabolic process or the anaerobic metabolic process.

The aerobic process consumes fuel in the presence of oxygen (supplied by the flow of blood) producing by-products, carbon dioxide and water, which are expelled by expiration and perspiration. The aerobic process provides the majority of the energy used by the slow acting muscle fibers (crucial to endurance activities).

The Anaerobic process occurs when there is not enough oxygen in the blood to produce energy aerobically. This process consumes carbohydrate as its primary source of fuel and does so in the absence of oxygen, producing a by-product called lactate. It is lactate which produces the muscle soreness and fatigue associated with excessive exercise. The anaerobic process provides the majority of the energy used by the fast-acting muscle fibres (crucial to strength and power activities).

When we start exercising, energy is initially produced anaerobically until the respiratory and cardiovascular systems respond and supply the oxygen necessary for aerobic energy production, hence the increase in breathing and heart rates. Once oxygen supply is sufficient, most of the energy will be produced aerobically, with the balance supplemented anaerobically. The lactate formed by this residual anaerobic production is easily dissipated by the body's organs, avoiding any onset of fatigue.

As exercise intensity increases the muscles' ability to produce energy aerobically will reach a limit (defined by the capacity of the respiratory and cardiovascular systems to supply additional oxygen). At this point the body cannot supply additional oxygen, and energy production becomes anaerobic. This transition point is the maximal aerobic output and is called the aerobic threshold. Exercise above this level causes a rapid build-up of lactate, leading to muscle fatigue which will cause cessation of exercise.

Knowledge of the aerobic/anaerobic process is essential to the successful attainment of specific exercise aims. Fat burn (weight maintenance), cardio-vascular training (cardio-vascular or endurance fitness) and anaerobic training (tolerance to fatigue) all rely on an understanding of the way our body produces energy.

WEIGHT MAINTENANCE

At lower intensities our body uses a mixture of fat and carbohydrate as its source of fuel. As the maximum aerobic output is approached, the percentage of fat consumed as fuel reduces to zero. Also, as the duration of exercise is increased the percentage of fat consumed tends to increase.

If your objective is weight maintenance, then it is necessary to burn as much fat (as opposed to carbohydrate) as the source of fuel as possible. This is best achieved at lower intensities and over longer durations. As soon as the intensity is increased the aerobic process starts to burn more carbohydrate and the weight maintenance effect will be reduced. A low intensity (60 - 70% of the maximal aerobic output) is typically that at which you can hold a conversation: it is by no means strenuous and is about that achieved by a brisk walk.

AEROBIC TRAINING

A sustained exercise program will improve the efficiency with which the respiratory and cardiovascular system can supply oxygen. This improves lung function, heart function, vascular efficiency and capillary growth, leading to improved well being and endurance.

At about 70 - 80% of the maximal aerobic output, lactate begins to accumulate in the blood supply at a greater rate than it can be extracted by the liver, kidneys and other organs. Exercising above this intensity will cause progressive accumulation of lactate in the blood, increased heart and breathing rates, cause muscle fatigue and will eventually lead to the cessation of exercise. Prolonged exercise at or below this intensity will maintain lactate at non-fatiguing levels and exercise duration will be limited solely to the depletion of available fuel stores.

If your exercise objective is aerobic (cardio-vascular/endurance) training then it is necessary to exercise at an intensity which will avoid fatigue due to lactate build up. This is best achieved at moderate levels of intensity over medium/long durations.

A moderate exercise intensity (70 - 80% of the maximal aerobic output) is about that achieved by a steady jog, avoiding the onset of muscle soreness.



ANAEROBIC TRAINING

Anaerobic training causes the build-up of lactate (as rapidly as one minute after exercise is commenced). Lactate saturation will necessitate either a rapid reduction in exercise intensity or complete cessation.

The accumulation of lactate limits the contribution of the anaerobic process to total energy production. Though energy may be generated rapidly, total work capacity and total power output is limited.

The level of intensity at which lactate begins to accumulate can be altered by training. This is best done by improving the efficiency of the aerobic process and is achieved by training at moderate levels of intensity. Exercising at anaerobic intensities may condition an athlete's tolerance to fatigue, but the benefit can be more psychological than physiological.

Prolonged exercise at high intensity not only impairs the weight reduction and aerobic training effect, but the rapid onset of fatigue can cause poor technique which may increase the risk of injury.

WHAT EXERCISE IS BEST?

Because the right exercise program is highly dependent on your health, age, general level of fitness, and overall exercise objectives, it is not appropriate for us to recommend specific exercise routines, but rather to offer guidelines. For more information contact your WaterRower agent.

We strongly recommend consulting a Physician or Exercise Physiologist prior to commencing any exercise program, as this will result in a program specifically tailored to your needs. This may also result in a program consisting of a variety of different activities which will broaden the range of exercise goals and help you gain greater satisfaction from an overall exercise program.

Feel free to consult our on-line training service for further up to date information and personalized advice; www.watercoach.com/home.

WORK OUT GUIDELINES

Objective - As previously discussed we strongly recommended that you have a clear idea of your work out objective and how to best optimize this objective, in terms of intensity and duration, prior to commencing.

Stretching - as outlined earlier, stretching is very important. We recommend that you consult a physiotherapist for stretches appropriate to your needs. Stretching will not only improve your flexibility, but will help prevent injury, and will leave you in a good, relaxed frame of mind for your work out.

Warm up - never start your exercise routine at full intensity. Even if you are short of time it is far better to shorten your work out then to commence it without a warm up. A slow progressive increase in intensity will allow your muscles to stretch and warm to their optimal condition. Failure to do this may lead to muscle strains or tears.

- Whatever your objective, don't set goals which are sky high, this may place undue strain on your body and may remove the pleasure which should be associated with exercise. Work comfortably within your limits: as it is far better to finish an exercise routine feeling relaxed and refreshed than thoroughly exhausted: the adage "no pain no gain" is simply false.

As your fitness improves so too will your achievements. The pleasure and benefit achieved by exercise is not realized by a single work out, but by a series of work outs over a period of weeks, months and years. Realizing this will enable you to maintain motivation and fitness for life.

If at any stage you feel dizzy or uncomfortable stop immediately, if the symptoms continue consult a physician.

- in much the same way as warming up prepared your muscles for a work out, warming down prepares your muscles for rest. Warming down correctly will cleanse your body of any lactic acid built up during your work out and will reduce the onset of stiffness and soreness.



- It is always useful to keep a record of your work outs, including such detail as how you felt during and after a work out. In this way you can monitor improvement. If you would like a WaterRower work out log contact WaterRower or visit our web site at www.waterrower.com.



WATERROWER PERFORMANCE MONITOR OPERATION

The Series III monitor has been designed to strike a balance between technical sophistication and user-friendliness. To achieve this we use text menu windows to guide you through the more advanced programming options.

BASIC OPERATIONS

Navigation is performed utilizing the four navigation buttons, the Start Button , the Mode Button , and the Scroll Buttons . The Series III monitor displays, Speed/ Average Speed (m/s- meters per second) and Power/Average Power (Watts) in the top right hand window, Distance covered in Kilometers in the top left hand window, Time in the bottom left hand window and Stroke rate (S/R) or Heart Rate (H/R, when option is fitted) in the bottom right hand window.

To Start the Monitor

Press the Start button, after a short welcome message the screen will be in Ready Mode, (all digits are flashing). Simply start rowing and the monitor will commence monitoring your work out. The monitor will shut off automatically after two minutes.

To Clear the Monitor Display

Double press the Start Button and the screen will clear.

To Program the Monitor

Select the Program Window using the Mode button.

Scroll to the desired Program Function using the Scroll buttons .

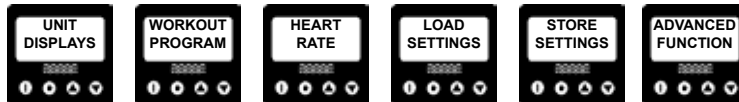

Select the desired Program Function using the Mode button.

Input the desired settings using scroll buttons .

Confirm your selection (or change digit windows) using the Mode Button.

Continue to set the Function Windows using the Scroll button to select  and Mode button to confirm, returning finally to the Ready Screen.

To return to the Ready Screen at any time press the Start Button.

PROGRAMMING UNIT DISPLAYS

The WaterRower Series III performance monitor allows you to display your work out intensity either as a replicated boat speed in meters per second (m/s), or as Power in watts. It also allows you to monitor average speed or average power of your work out. For many users the units display is not important and for this reason the monitor defaults to the most common unit, m/s.

To Program Unit Option

Enter the Units window using the Mode button.



Using the scroll buttons  select your desired units (m/s, watts, m/s average or watts average).



Press the Mode button to confirm the selection.

The monitor will return to the Ready Screen with the new units selection displayed.



PROGRAMING WORK OUTS

The WaterRower Series III performance monitor allows you to set different work out objectives. You can preset a time and work down to zero. You can preset a distance and work down to zero. Or you can set up to nine periods of work (in either Distance or Time) followed by periods of rest (Time).

At the end of each work period the WaterRower Series III Performance Monitor displays your average speed and average stroke rate for the period.

To Program Timed Work Outs

Enter the work out window using the mode button.



Use the scroll buttons  to select Timed work out, press Mode to confirm.



Use the scroll buttons  to select the work out duration (minutes), pressing Mode to confirm.

Use the scroll buttons  to select the work out duration (seconds), pressing Mode to confirm.



The monitor will return to Ready Mode with the desired work out time displayed. Pressing the Start button at any time during setting will return you to ready mode.

To Program Distance Work Outs

Enter the work out window using the Mode button.



Use the scroll buttons  to select Distance Work Out, press Mode to confirm.



Use the scroll buttons  to select the work out distance (kilometers) pressing Mode to confirm.

Use the scroll buttons  to select the work out duration (decimal kilometers) pressing Mode to confirm.



The monitor will return to Ready Mode with the desired work out distance displayed. Pressing the Start button at any time during setting will return you to ready mode.

To Program Interval Work Outs

Enter the work out window using the Mode button.



Use the scroll buttons  to select Interval Training, press Mode to confirm.





Use the scroll buttons  to select the number of WORK cycles (two to nine), pressing Mode to confirm.





Use the scroll buttons  to select the WORK interval type (Time or Distance), press mode to confirm.



or



Use the scroll buttons  to select the WORK duration (minutes or kilometers), pressing Mode to confirm.

Use the scroll buttons  to select the WORK duration (seconds or decimal kilometers), pressing Mode to confirm.



or



Use the scroll buttons  to select the REST duration (minutes), pressing Mode to confirm.

Use the scroll buttons  to select the REST duration (seconds), pressing Mode to confirm.



or



Continue this procedure for each interval (two to nine) . After the first interval is set the subsequent intervals will default to these settings.

If you want common WORK and REST intervals then do not alter these default figures.

If you want unequal WORK or REST intervals use the scroll buttons  to alter the defaults as above.

At the end of the programing sequence the monitor will revert back to ready mode with initial WORK period displayed.

PROGRAMING HEART RATE OPTION

The WaterRower Series III monitor incorporates a heart rate (HR) monitoring facility which requires additional hardware to activate. We highly recommend the use of heart rate monitoring as the most accurate method of monitoring physiological intensity. With the heart rate option fitted, the WaterRower Series III monitor displays heart rate in the stroke rate window 70% of the time.

The WaterRower Series III monitor also allows you to select a variety of heart rate zone setting options, HI LO, Maximal Intensity, Exercise objective and Intensity settings. A visual and audible signal alert you when you are outside the set zone.

Hi Lo HR Zone- allows you to manually set the maximum HR above which the HI warning will activate and the minimum HR zone below which the LO warning will activate.

Maximal HR Zone- allows you to manually set your maximal HR (being your aerobic threshold), your resting HR (being your waking HR) and your desired exercise intensity (%). The Series III monitor will automatically calculate your desired HR and set the maximum and minimum thresholds (+/- 10 beats). You may change your calculated thresholds manually if you so desire.

Objective HR Zone- allows you to manually set your age (no cheating now), your resting HR (being your waking HR) and your desired exercise objective (fat burn, aerobic or maximal). The Series III monitor will automatically calculate your desired HR and set the maximum and minimum thresholds (+/- 10 beats). You may change your calculated thresholds manually if you so desire.

Intensity HR Zone- allows you to manually set your age, your resting HR (being your waking HR) and your desired exercise intensity (%). The Series III monitor will automatically calculate your desired HR and set the maximum and minimum thresholds (+/- 10 beats). You may change your calculated thresholds manually if you so desire.



To Program Hi Lo HR Zones

Enter the heart rate zone window using the Mode button.



Use the scroll buttons to select the Hi Lo option, pressing Mode to confirm.



Use the scroll buttons to enter the maximum desired heart rate, pressing mode to confirm.



Use the scroll buttons to enter the minimum desired heart rate, pressing Mode to confirm.



The monitor will return to Ready Mode with the desired heart rate zone set. A visual and audible signal alert you when you are outside the set zone.

To Program Maximal HR Zones

Enter the heart rate zone window using the Mode button.



Use the scroll buttons to select the Maximal option, pressing Mode to confirm.



Use the scroll buttons to enter your maximum heart rate, pressing mode to confirm.



Use the scroll buttons to enter your resting heart rate, pressing Mode to confirm.



Use the scroll buttons to enter your desired intensity of exercise (%), pressing Mode to confirm. Your calculated maximum will then be displayed, you may use the scroll buttons to modify it if you wish, pressing Mode to confirm.



Your calculated minimum will then be displayed, you may use the scroll buttons to modify it if you wish, pressing Mode to confirm. The monitor will return to Ready Mode with the desired heart rate zone set. A visual and audible signal alert you when you are outside the set zone.



To Program Objective HR Zones

Enter the heart rate zone window using the Mode button.



Use the scroll buttons to select the Objective option, pressing Mode to confirm.



Use the scroll buttons to enter your age, pressing mode to confirm.



Use the scroll buttons to enter your resting heart rate, pressing Mode to confirm.



Use the scroll buttons to select your desired exercise objective (fat burn, aerobic or maxim)



Your calculated maximum will then be displayed, you may use the scroll buttons to modify it if you wish, pressing Mode to confirm. Your calculated minimum will then be displayed, you may use the scroll buttons to modify it if you wish, pressing Mode to confirm. The monitor will return to Ready Mode with the desired heart rate zone set. A visual and audible signal alert you when you are outside the set zone.

To Program Intensity HR Zones

Enter the heart rate zone window using the Mode button.



Use the scroll buttons to select the Intensity option, pressing Mode to confirm.



Use the scroll buttons to enter your age, pressing mode to confirm.





Use the scroll buttons to enter your resting heart rate, pressing Mode to confirm.



Use the scroll buttons to enter your desired exercise intensity (%), pressing Mode to confirm.





Your calculated maximum will then be displayed, you may use the scroll buttons  to modify it if you wish, pressing Mode to confirm. Your calculated minimum will then be displayed, you may use the scroll buttons  to modify it if you wish, pressing Mode to confirm. The monitor will return to Ready Mode with the desired heart rate zone set. A visual and audible signal alert you when you are outside the set zone. Using the scroll buttons  select the program position you wish to load from, pressing the Mode to confirm.

PROGRAMING PROGRAM STORAGE

The WaterRower Series III monitor allows you to save up to five sets of work out settings which may be recalled at a later time.

To Store Program Settings

Select the Store Settings window using the Mode button.



Using the scroll buttons  select the program position you wish to store to, pressing Mode to confirm.



Your current monitor settings will be stored to that program position.

To Load Program Settings

To load your settings- enter the Load Settings window using the Mode button.



Using the scroll buttons  select the program position you wish to load from, pressing the Mode to confirm.



The settings stored in the selected program position will be loaded into the current monitor settings.

PROGRAMING ADVANCED FUNCTIONS

The WaterRower Series III monitor has numerous advanced function features including;

Language - allowing a selection of English, French, Italian and German.

Custom Welcome - allowing you to customize the welcome message.

PC Comms - allowing you to select various PC interface options including;

RS232 Baud rate - 1200 or 2400 baud rates

System upload - upload of data to the monitor

System download - download of data from the monitor

Factory Defaults - allowing you to reset the monitor settings to the factory settings.

To Program Advanced Functions

Enter the advanced function window using the Mode button.

Use the scroll buttons  to select the desired option, pressing Mode to confirm. Use the scroll buttons

 to select the various sub-options, pressing mode to confirm.



HEART RATE MONITORING

As discussed earlier, exercising at the correct intensity is a very important part of optimizing the effectiveness of your exercise program.

Exercise intensity measured in terms of distance or speed is very subjective as it depends on the individual's physiology, age, weight, sex, physical condition, etc.. And can often vary according to an individual's tiredness, hydration, stress, and general well being.

Individual exercise intensity is a measure of how much work your body is doing. The most convenient method of measuring your physiological intensity is to monitor heart rate.

Your maximum heart rate, which corresponds to your maximum aerobic output, can be estimated using a simple equation based upon your own age.

For women: $226 - \text{Your age}$.

For men: $220 - \text{Your age}$.

For example, a 30 year old man could estimate his maximum heart rate as follows: $220 - 30 = 190$ beats per minute (b.p.m.)

If he wants to exercise at an intensity of 60%, his target heart rate will be:

Target heart rate = $60\% \times 190 = 114$ b.p.m.

There are many heart rate monitors on the market which will allow you to monitor your pulse. Please consult your WaterRower agent for further details.

START UP MAINTENANCE

In the first couple of weeks of use the wood in your WaterRower will adjust to the temperature and humidity of the environment. During this period it is strongly advised that you gently tighten all the connecting bolts with the allen key stored under the rear spacer.

Additionally, as the drive and recoil belts tighten up with use, it may be necessary to tighten the bungee cord. To do this, leave the handle in the full forward position and adjust the bungee/recoil belt buckle to provide a little more tension. It will only be necessary to perform these two simple start up procedures once or twice over the first month of use.

PERIODIC MAINTENANCE

Periodic maintenance is required to maintain the condition of the water in the tank. We strongly advise using municipal tap water which contains chlorine and other chemicals to keep it free from bacteria and algae, etc.. The chlorine must be refreshed periodically by adding a water purification tablet provided in the back of the owner's manual. Chlorine degrades by exposure to light: this may vary from 6 months in direct sunlight to 2 years in an artificially lit environment. If water discoloration occurs add a purification tablet immediately. If the water does not clear, we recommend emptying the tank, flushing it out with clean water, and refilling, adding a purification tablet. Never use chlorine bleach in the tank as this will irreparably damage the polycarbonate tank.

Should the environment in which the WaterRower is stored be subject to freezing, we recommend adding alcohol to the water.

CLEANING

To maintain the appearance and integrity of your WaterRower it is necessary to keep the machine clean. It is particularly important to ensure that there is no dust build up in the clutch and belt mechanism between the top and bottom decks. Dust can be removed by using a vacuum cleaner.

The surface of the rails must be kept clean to prevent dust fouling the seat wheels, and can be cleaned by wiping with a damp cloth.

The surface of the tank can be cleaned, however, please ensure you read the instructions for any cleaning fluids prior to use: do not use methylated chlorates or ammonia based fluids.



MAINTAINING THE WOOD

The natural wood WaterRowers are finished with Danish Oil which gives a deep penetrating finish to the hardwood frame. Other than occasional dusting or polishing, the wood requires no maintenance. Over time, expect your Oxbridge WaterRower to develop a wonderful dark patina.

ASSEMBLY

Your WaterRower comes partially assembled in two boxes for protection during transit and for economy of shipment. Assembling your WaterRower should take about half an hour. The tools you will need have been provided.

We have all experienced the frustrations caused by incomprehensible assembly instructions. For this reason we have gone to added effort to make our instructions as clear and concise as possible. Do not be intimidated by the detail:- it is simply intended to make the assembly process as comfortable as possible for you.

STEP ONE

Lay the rails on the floor, black rail extrusions facing in, and connect the rear spacer using the male JCN nuts and the allen key provided. The allen key can be found attached to the rear spacer.

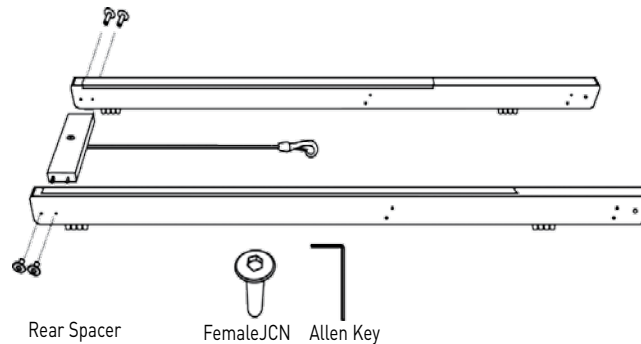

STEP TWO

Sit the seat between the rail, with the indent on the seat facing towards the rear of the machine, (to allow for clearance of the tail bone). It may be necessary to slightly separate the rails to allow the seat to sit into place.

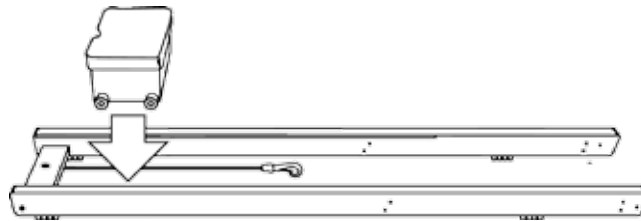

STEP THREE

Place the tank assembly between the rails.

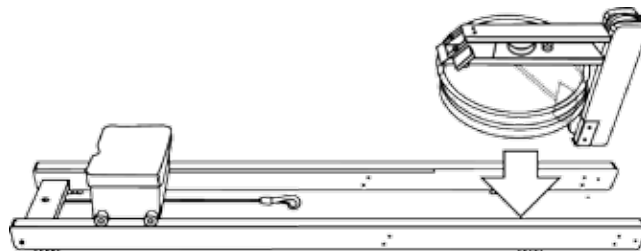



STEP FOUR

Place the foot board between the rails positioning the top two holes over the two threaded holes in the black tank unit. Screw the handle rests into position using the handle rest bolts. It may be necessary to slightly loosen the two bolts on the top deck (A) to allow the footboard clearance.

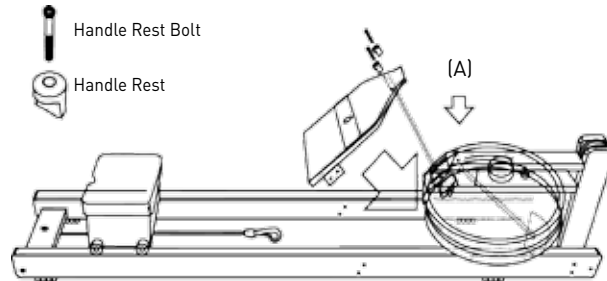

STEP FIVE

Insert the JCN nuts and JCB Bolts attaching the tank and the footboard to the rails at A & B. The nuts should be placed on the inside and the bolts on the outside. Should you experience any problem with aligning the components, loosen all the fasteners, align and re-tighten.

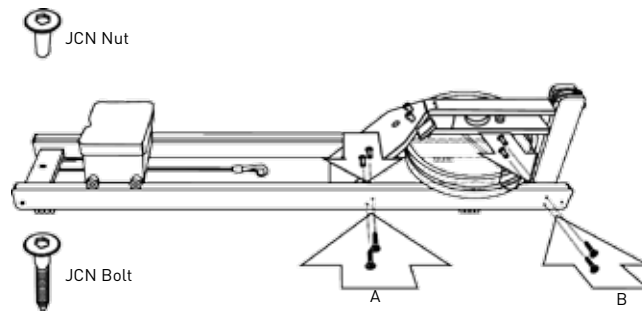

STEP SIX

Press the heel rest adjustment button (A) and insert the heel rest/foot pads into the foot board cover plate (B).

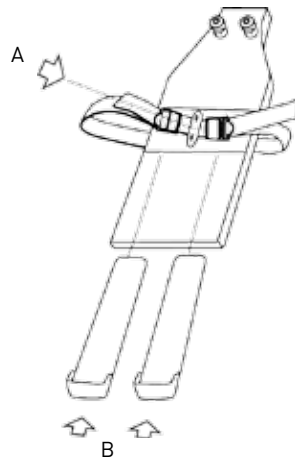



STEP SEVEN

Undo each Dolley Wheel assembly (2) and fix to each rail as shown and tighten with the allen key provided.

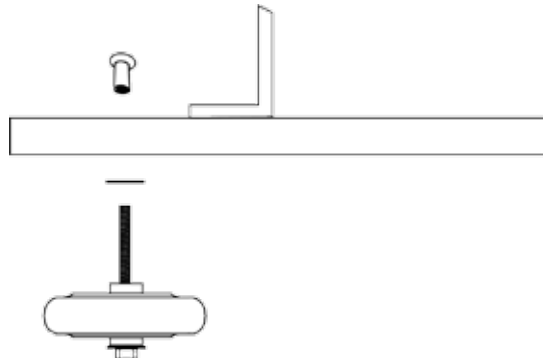

STEP EIGHT

Stand the WaterRower upright and connect the bungee to the recoil strap

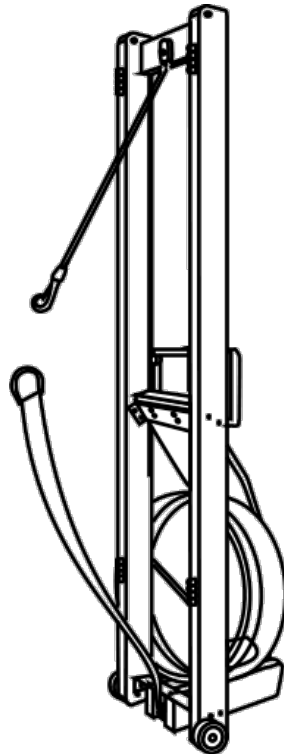

STEP NINE

Some things to check before filling the tank and rowing.

Tacho Belt- there is a small green tacho belt which is under the top deck of the machine, immediately above the clutch assembly around which the drive strap is wrapped. During shipment this can sometimes become dislodged effecting the monitor function. If the tacho belt has dislodged, gently lift the tacho belt back onto its pulleys using a slender screwdriver. Ensure that the two tacho pulleys are correctly aligned. If not the position of the small tacho pulley may be adjusted by sliding it up or down the tacho motor spindle.

Recoil Belts- ensure that the recoil belts pass smoothly over all three guide pulleys.



STEP TEN

Lay the WaterRower down and using the syphon pump provided (or a hose if available) fill the tank to the desired level with chlorinated town or municipal water. Do not use distilled or purified water as these have had the additives essential to deterring algae growth removed. Should your local water be only lightly chlorinated it may be necessary to place one of the chlorine tablets provided in the rear of this manual into the tank, (refer the section on Periodic Maintenance on page 22).

Do not over fill your WaterRower, anything more than half full (above the bottom edge of the paddle shaft when the machine is standing) may risk leaking, (refer to the section on Water Level on page 3).

Insert the stopper (it may be necessary to lightly moisten the stopper to assist replacement).

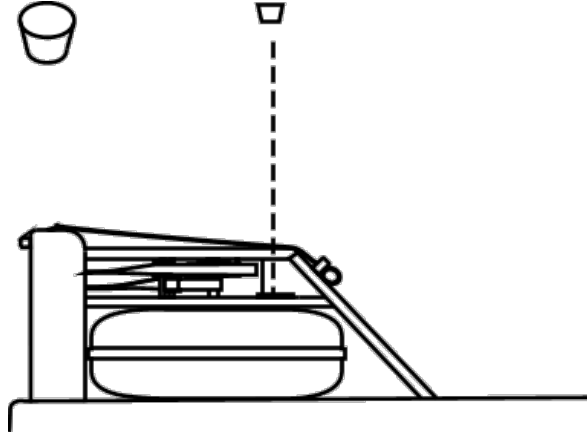

Congratulations, your WaterRower is now ready for use.

Please review the Maintenance section on page 22.

TROUBLESHOOTING

Battery replacement.

The Batteries are located underneath the top deck, behind the footboard and adjacent to the stopper in the tank. To replaced remove the battery holder from its clip and replace batteries one by one being sure to follow the orientation of the batteries marked on the battery holder.

Bolts will not fit in the holes.

Loosen all bolts and try again.

Using a spanner loosen the screws on the back of the foot board bracket (tank unit bracket) slightly. Remember to tighten later.

If the rails holes and bracket holes are not lining up, it may be possible that the foot board bracket or tank unit bracket is upside down. To fix this, use a spanner to remove and replace the bracket.

Monitor does not come on.

Check batteries are fitted correctly. (Batteries may be dead)

Remove the monitor back plate with a screwdriver and check that the two plugs are firmly connected. If there is no change, remove circuit board and return to us for a replacement.

Monitor does not work properly.

Check that the dark green rubber band at the top of the clutch is connecting the clutch to the small pulley wheel that sends information to the monitor. If it is not, then by using tweezers, stretch the green band around the small pulley wheel.

Check that the drive belt is not touching the green rubber band or the small pulley wheel.

Check that the plastic wheel that is sitting in the clutch is not rising up. If it is push back in. If this happens again, then remove the top deck panel, take the piece out and replace after spreading a little super glue around it. After replacing the top deck panel remember to replace the green rubber band.

Check and make sure that the tachometer is connected to the computer.

Erratic Stroke Rate Ratings

Check that the tacho or tacho pulley is not hitting anything. If the tacho pauses it indicates the end of the stroke and will hence register a higher than expected stroke rate.



WARRANTY

WaterRower Inc. (WaterRower) will replace or repair at its factory or nominated service center any WaterRower or WaterRower component found to be defective in material or workmanship for a period of THREE (3) YEARS from the date of initial shipment by WaterRower.

This warranty will be invalid if, in the opinion of WaterRower, the claim has been caused by: (a) accident, abuse, misuse, misapplication or as a result of any modification other than by WaterRower; (b) deterioration due to normal wear and tear (c) improper preventative maintenance steps as described in the WaterRower manual.

Return of the WaterRower or WaterRower component to WaterRower's factory or nominated service center will be the responsibility of the claimant.

The WaterRower or component should be packed to protect it from damage, WaterRower will not be responsible for any damage which may occur during shipment. Postage should be prepaid and the package should contain the claimant's name, address and telephone number, a description of the problem, and proof of purchase.

WaterRower will return the WaterRower or WaterRower component to the claimant at its (WaterRower's) expense except in the case where the warranty has been deemed invalid. In the event that the warranty is found to have been invalidated, then the costs of such investigation, repair and any associated shipping costs shall be borne by the claimant.

This warranty is not transferable. Should ownership of the WaterRower be transferred then the warranty may be transferred at additional cost. WaterRower warrants against any defective WaterRower spare part received from WaterRower or any authorized dealer for a period of NINETY (90) DAYS after the date of shipment.

WaterRower Inc. shall not be liable for any direct, consequential, incidental indirect or special damages under this warranty, or any implied warranty.

The warranty described in this paragraph shall be in lieu of any other warranty, expressed or implied, including but not limited to, any implied warranty of merchantability or fitness for a particular purpose.

The term of this warranty does not affect or prejudice the statutory rights of a consumer, neither does it limit or exclude any liability for death or personal injury caused by WaterRower's negligence.